

SINCE 1908
wessels
 company

SUBMITTAL

AP-SERIES
 IN-LINE AIR PURGERS

Models: AP-104 thru AP-124
 Submittal Sheet No. D-1102A

Date: 4/18

Job Name _____	Submitted By _____	Date _____
Location _____	Approved By _____	Date _____
_____	Order No. _____	Date _____
Engineer _____	Notes _____	
Contractor _____	_____	
Sales Rep. _____	_____	

Description

Wessels In-Line Air Purgers are used for commercial and industrial hydronic systems to effectively control and eliminate entrained air. The purger is designed with an embossed flow indicator arrow for proper installation. The purgers are fabricated to conform to ASME requirements.

Construction

Fabricated steel

Performance Limitations

Maximum Design Temperature: 450°F
 Maximum Design Pressure: 150 PSIG

Model Number	Part Number	Max Flow (GPM)	Tagging Information	Quantity
AP-104	75010449	300		
AP-105	37620050	530		
AP-106	37620060	850		
AP-108	37620080	1900		
AP-110	37620100	3200		
AP-112	37620120	4800		
AP-114	37620140	6100		
AP-116	37620160	8000		
AP-118	37620180	9700		
AP-120	37620205	12000		
AP-124	37620240	17000		

Typical Specification

Furnish and install, as shown on plans, an In-Line Air Purger Model AP- _____ equipped with internal flow baffle, as manufactured by Wessels Company. The air purger shall be constructed for 150 PSI @ 450°F.

Each air purger shall be Wessels model number AP- _____ or approved equal.

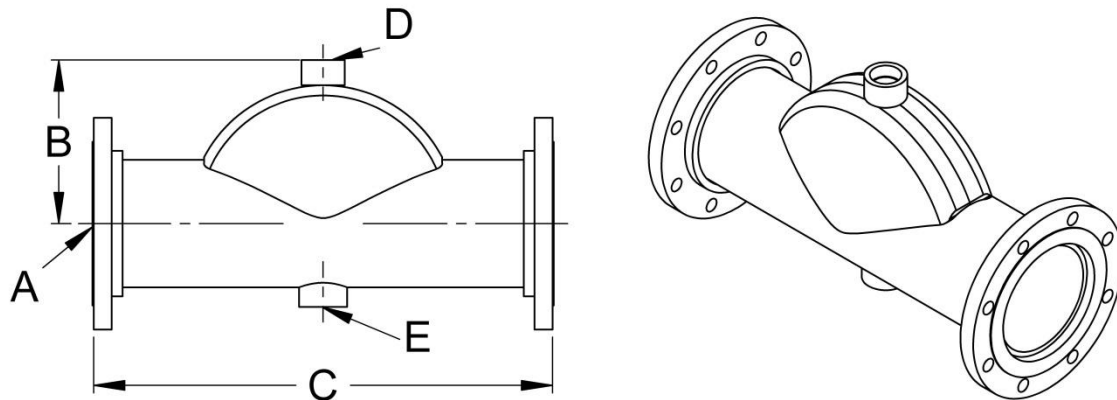

AP-104 thru AP-124

Dimensions & Weights

Model	Dimensions In Inches					Shipping Weight (lbs)
	Dimensions			Tappings		
	A	B	C	D	E	
AP-104	4	5	12	3/4	1/2	38
AP-105	5	7 1/2	20	1 1/4	1 1/2	60
AP-106	6	8 1/2	24			65
AP-108	8	11 1/4	32			110
AP-110	10	14	40			165
AP-112	12	16 3/4	48			315
AP-114	14	19 1/4	56			475
AP-116	16	21 1/4	64			510
AP-118	18	23 1/2	72			545
AP-120	20	26 3/4	80			997
AP-124	24	33 3/4	96			1368